



Gurzil Raman Microscope



Thunder Optics

Gurzil Raman Microscope

TO-RM-S-532 / TO-RM-S-785



Thunder Optics

— Science and knowledge for all —



The **Gurzil Raman Microscope** is ideal for daily, routine Raman spectroscopy, and it is perfectly optimized for a laboratory workspace. The Microscope is constructed by incorporating the best features of a metallurgical microscope, a spectrometer of high performance and Raman optics. Taken together, this has made the Gurzil Raman Microscope the instrument of choice for routine, laboratory measurements, and the instrument of choice for providing guidelines for advanced research. The microscope functions with a 532 nm or 785 nm laser which renders the instrument highly polyvalent; hence, the model can be used for a variety of applications.

A high-performance optics system binds the spectrometer, the laser, Raman Cube[®], and the microscope together. The Raman microscope permits Raman shifts ranging from 110 cm^{-1} to 4000 cm^{-1} . The spectral resolution ranges from 8 cm^{-1} (the smallest possible aperture of the optic) to 30 cm^{-1} . The spatial resolution has the ability to reach 10 μm with a

«Having a research-grade Raman system like the Gurzil, which works equally well in a campus laboratory and in a field house for an archaeological dig, is highly advantageous for us. I expect that our Gurzil system will see a lot of use both on campus and in various places around the world.»

Yale

Ellery Frahm
Director of Yale Initiative
for the Study of Ancient Pyrotechnology,
Yale University.

strong magnification (100x). An additional option of the Gurzil Raman Microscope is a camera which may be installed on a trinocular. The camera captures images and record videos of microscopic areas of interest. This microscope is an extremely useful instrument both in terms of performance and sensitivity.

SPECTROMETER ALMAD-0

The Gurzil Raman Microscope uses the **Spectrometer Almad-0***, which is a high-resolution spectrometer cooled to $-35\text{ }^{\circ}\text{C}$ below the ambient temperature with TEC technology. This is a major advantage for measuring weak Raman signals which can be cleaned by the thermoelectric noise of a standard spectrometer. Thus, an acquisition time of even several dozen minutes is possible.

The spectrometer is equipped with a variable slit ($0\text{ }\mu\text{m}$ to $600\text{ }\mu\text{m}$). It is sufficient to pass the micrometric face from a lower resolution to another resolution without dismantling the slit or stopping measurements.

* The third party product.

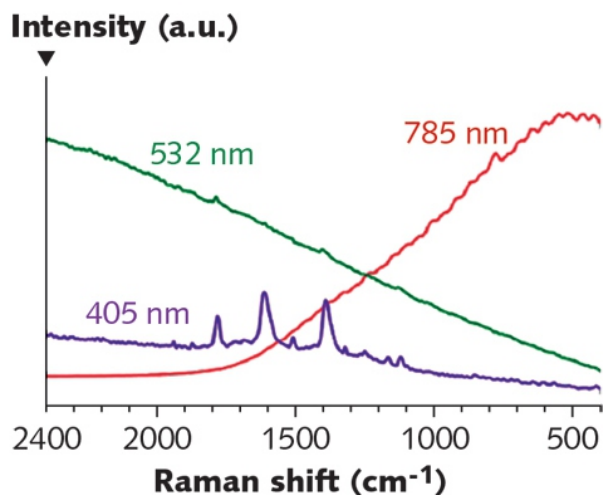
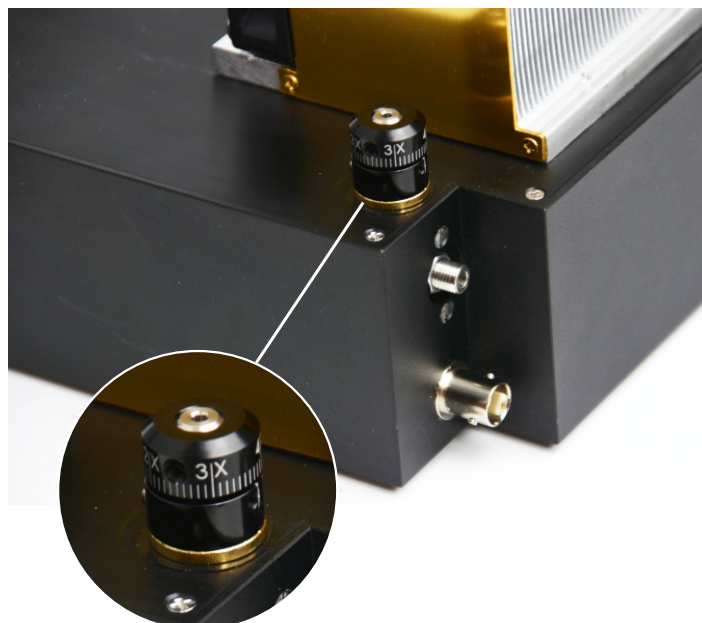

LASER

The Gurzil Raman Microscope TO-RM-S-532 uses a **532 nm laser** with 0.3 nm linewidth as the excitation source. The power is adjustable from 0 to 50 mW. For the Gurzil Raman Microscope TO-RM-S-785 it is a **785 nm laser** with 0.2 nm linewidth, where the power is adjustable from 0 to 300 mW.*

* The lasers have a 2-year warranty.

RAMAN CUBE®

The Gurzil Raman Microscope has a unique advantage as it functions as a microscope when connected from the Raman probe to the Thunder Optics optic system which is called the Raman Cube®. Likewise, when functioning just as a Raman probe, it only requires disconnecting the Raman probe from the Raman Cube®. This action allows for the use of the probe independent of the microscope.

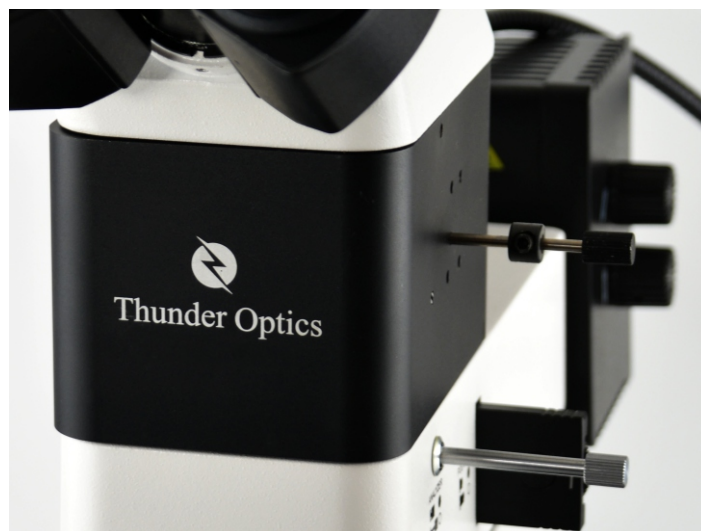

RAMAN PROBE

The Raman probe can be applied in a variety ways:

- 1 A handled Raman probe.
- 2 Connected to the Raman Cube®.
- 3 With cuvette holder for liquid samples.

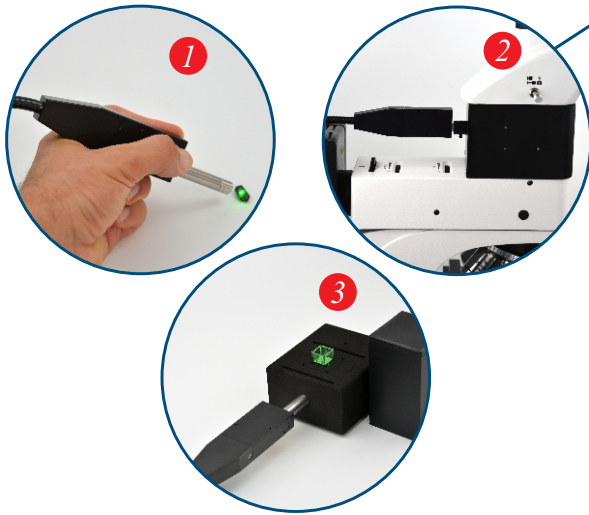

For better visual analysis of samples and to show significant contrasts between micro-grains, the Gurzil RamanMicroscope is equipped with a light source coupled with a polarizer/analyzer, a set of filters, and a diaphragm to differentiate materials making up the sample.

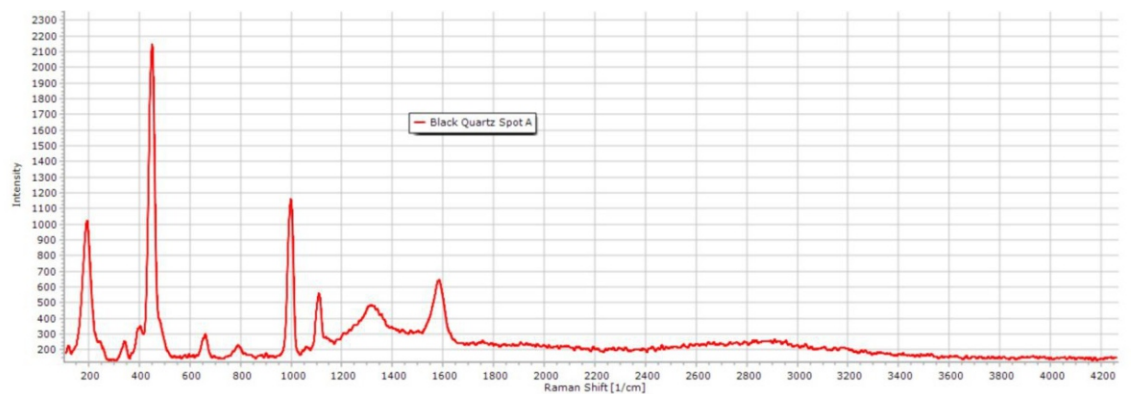
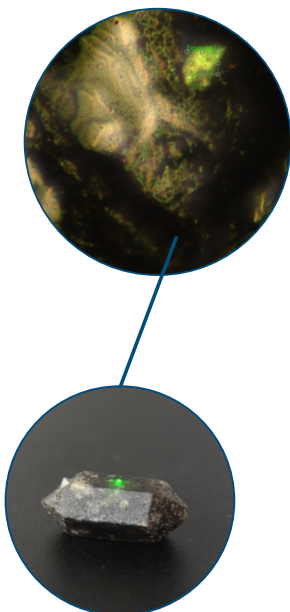
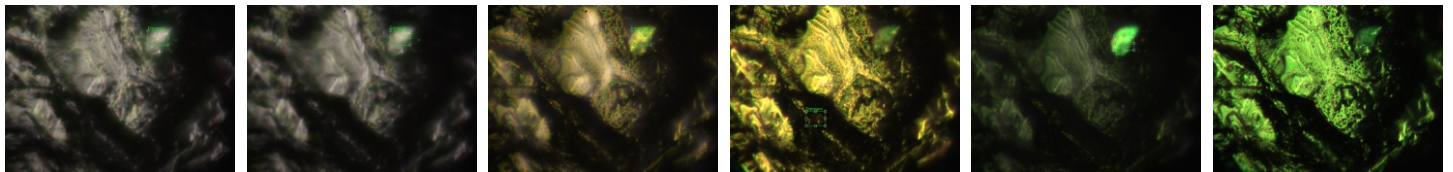

BENEFITS

- Compact, high efficiency Raman Microscope.
- Variable slit provides a wide range of resolutions.
- Powerful adaptability is relative to the analysis of your sample.
- Large range of possible applications.

FEATURES

- The Microscope and probe modes are functions of the same instrument.
- Raman shift range from 110 cm^{-1} to 4000 cm^{-1} with 8 cm^{-1} as a maximum resolution.
- USB 2.0.
- Handy easy to use.
- Variable slit from zero to 600 μm .
- Trinocular permitting visual and camera observations (taking pictures and videos of the sample during the light polarization changes).
- Compatible with Spectragryph software.

SOFTWARE

For non-commercial use, we provide research-grade software. This software has wide ranging functionality which includes measurements of intensity, absorbance transmission, Raman, etc.

DELIVERY PACK

- Raman Cube© Optical System.
- Raman probe.
- Full metallurgical microscope.
- Spectrometer Almad-0.
- 532 nm laser with 0.3 nm linewidth OR 785 nm laser with 0.2 nm linewidth.
- Electrical cables.
- Spectragryph Software (includes a license for all noncommercial users).

RECOMMENDED ACCESSORIES

- Digital scientific grade camera.
- Stand for the Raman probe.
- Cuvette Holder for liquid samples.
- Advanced license for the software.

APPLICATIONS

- Gemology.
- Geology and Mineralogy.
- Environmental science.
- Semiconductor & Solar industry.
- Food & Agriculture industry.
- Pharmaceutical industry.
- Chemical processes.
- Medical diagnosis.
- Forensic analysis.



For non-commercial use:

*\$17,900** – Gurzil Raman Microscope
TO-RM-S-532

*\$19,800** – Gurzil Raman Microscope
TO-RM-S-785

* United States Dollar

Please, contact sales@thunderoptics.fr
for commercial use license.



SAMPLES

DIAMOND

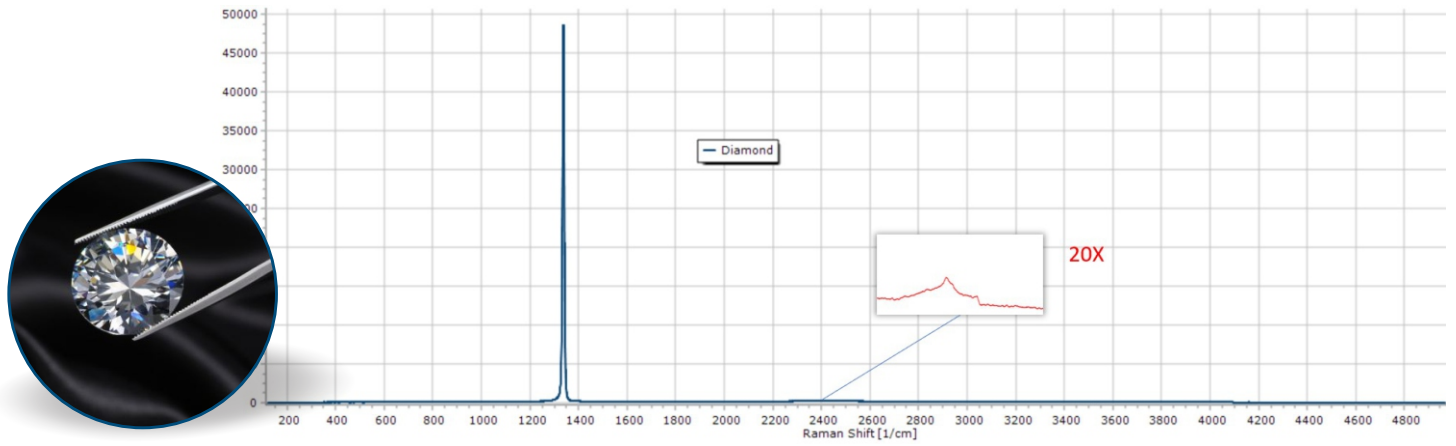

PARACETAMOL

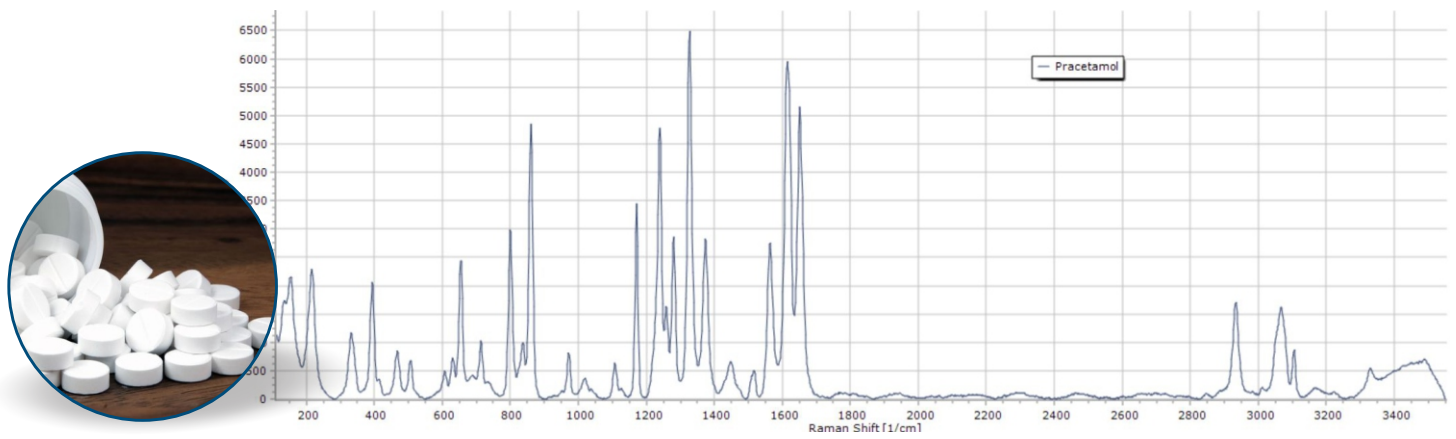

SILICON CARBIDE NANOPARTICLES

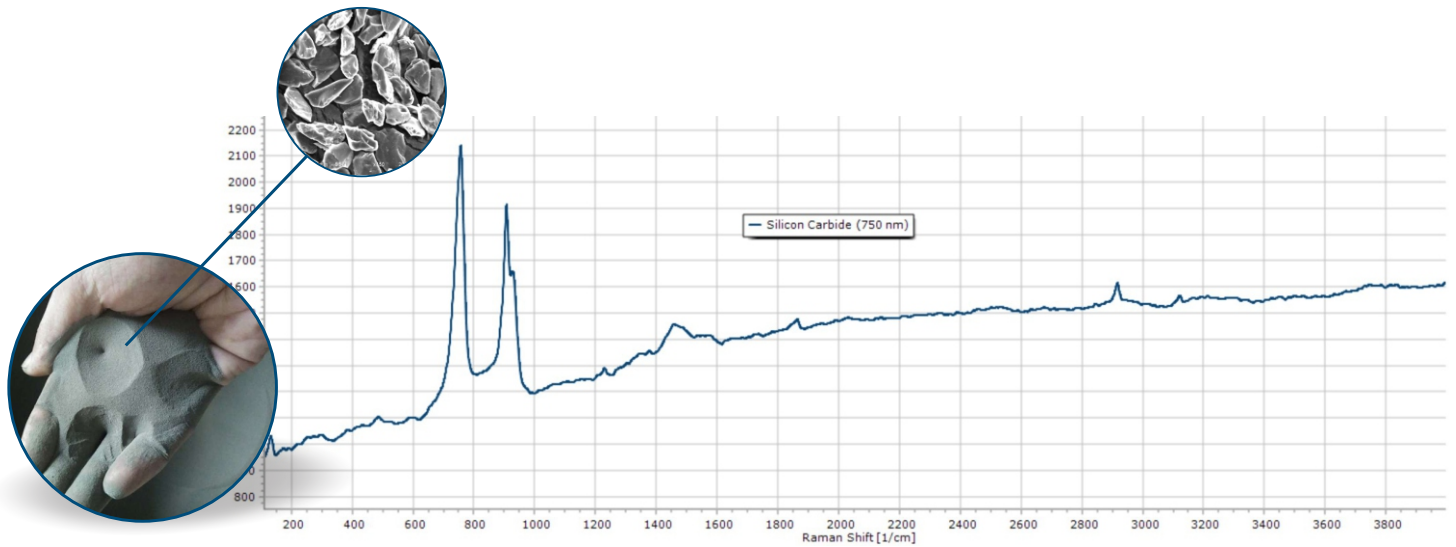

MICROSCOPE PARAMETERS

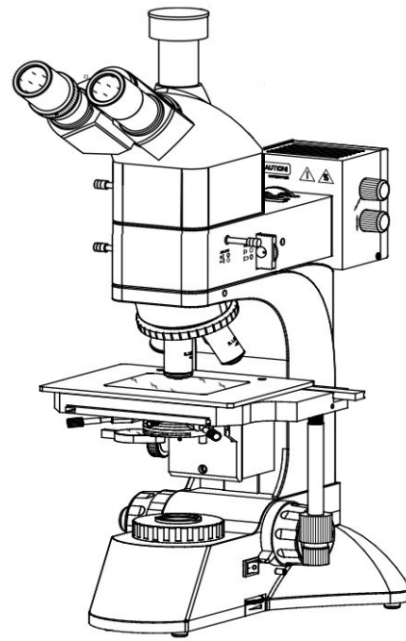

Specification	Trinocular Metallurgical microscope				
Optical System	Infinity Optical System				
Head	Trinocular Head, 30° Inclined, 360° Rotatable				
Nosepiece	Backward nosepiece				
Stage	Double Layers Mechanical Stage 140×210 mm Moving Range 63×50 mm Fine Division 0.1 mm				
Focusing System	Coaxial Coarse and Fine Adjustment, Fine Division 0.002mm Coarse Stroke 37.7 mm/ Rotation Moving Range 28mm With Safety Stop				
Illumination	6V/20 W Halogen Lamp, Brightness Adjustable				
Adapter	C-Mount 1.0x				
Condenser	Abbe Condenser NA1.25 with Aperture Diaphragm				
Power Supply	External Power Adaptor, Wide Voltage AC 100~240V, DC 5V/2A				
Filter	Blue filter Ø 38 (Not Available For LED Illumination)				
Package Size	Packing Box 10x24x29 cm, 1 pc/Box				
Gross weight	15KG				
Eyepiece	Large field of view High eye point flat field eyepiece WF10X, (WF16X Optional) Binocular Interpupillary Distance 48-75 mm Tube Diopter Adjustable				
	Field	WF10X/22mm		12.5X(optional)	
	Infinite PL L Apochromatic Objective				
Objective lens	Magnification	5X	10X	20X/40X	50X/60
	Condenser NA	0.12	0.25	0.4/0.6	0.5/0.7
	Distance(mm)	8.05	7.86	7.2	3.68

The Microscope Brochure has a full description of the microscope. It can be provided upon request.